

Varenummer: 2302151112
Beskrivelse: E+G Høj Fingermetrik
B.259/25 S-M8 CLEAN

Mål

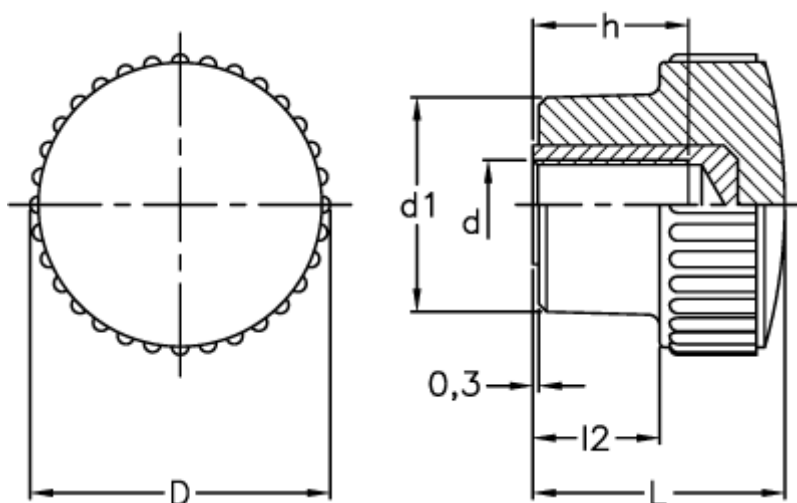

D	= 26
d1	= 16
d 6H	= M8
h	= 13
L	= 28
l2	= 15